

BOOST SIDELOADER SET INSTALLATION

For Benno® Boost **WITH POLY WHEEL GUARDS**

COMPATIBILITY

BOOST EVO 1,2,3,4,5

FOR BOOST **EVO**LUTION FINDER GO TO:
BENNOBIKES.COM/BOOST/EVOLUTION

EVO (evolution) replaces model years and refers to design generations.

READ CAREFULLY BEFORE INSTALLATION AND USAGE. TO BE INSTALLED BY MECHANIC AT AUTHORIZED BENNO DEALER.

IMPORTANT: *Notes to mechanic:* See Instructions. Install Benno Boost Sideloaders only on compatible Benno Boost models in combination with selected Utility Rear Racks. Use only original (included) hardware and pre-drilled holes and fittings. Do not mount Sideloaders to damaged bikes or racks. Do not modify Sideloaders, racks or bikes, change position or drill new holes as this will void any warranties and/or claims for liability.

Notes to owner: Periodically check to make sure all bolts remain tight as vibrations may loosen them. Ensure that either Benno Wheel Guards or Utility Pannier Bags remain on the bike while carrying passengers.

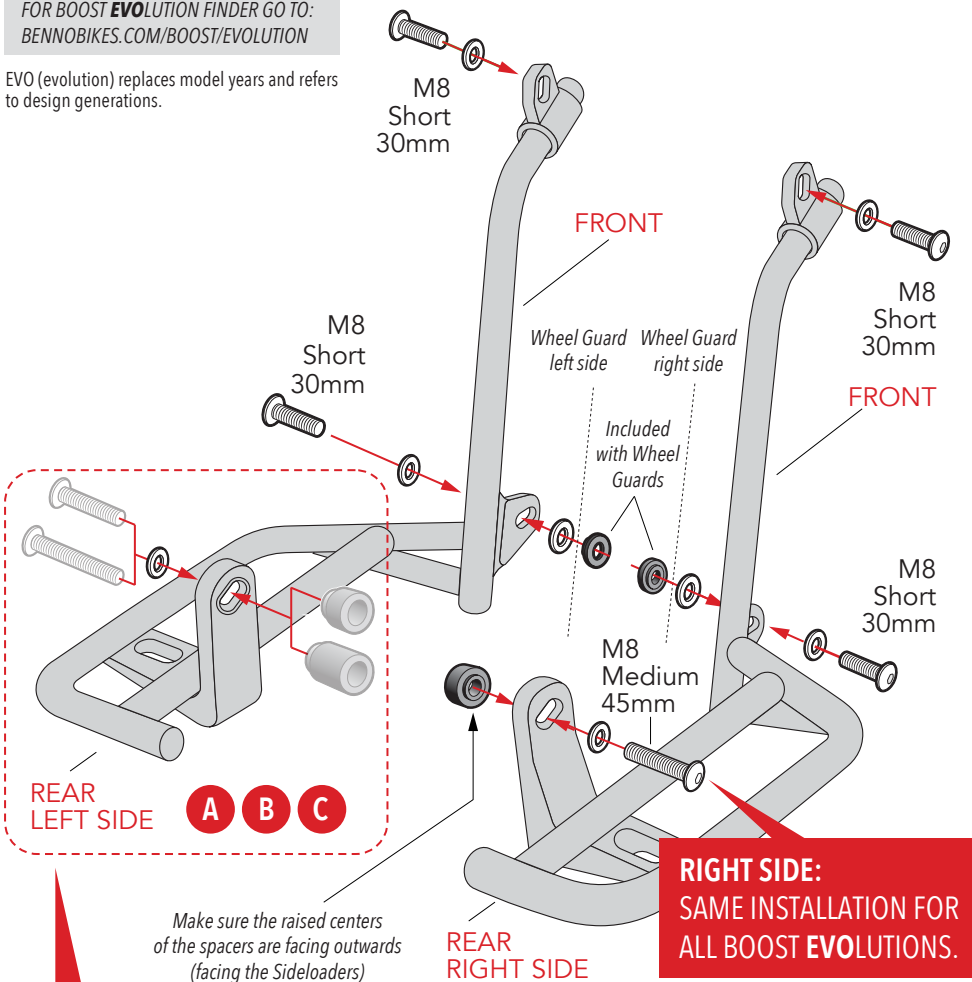

Hardware

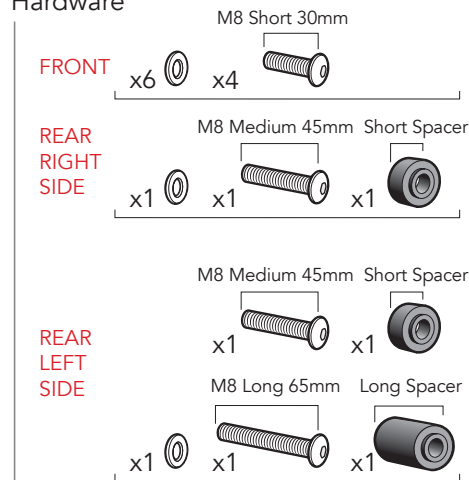

PLEASE NOTE: Select needed hardware according to description below. **Not all hardware included will be used.**

LEFT SIDE: SELECT INSTALLATION OPTION (A, B OR C) DEPENDING ON YOUR BOOST EVOLUTION AND RACK CONFIGURATION. SEE OPTIONS BELOW. FOR BOOST EVOLUTION FINDER GO TO BENNOBIKES.COM/BOOST/EVOLUTION

A For Boost (EVO 1,2,3,4)

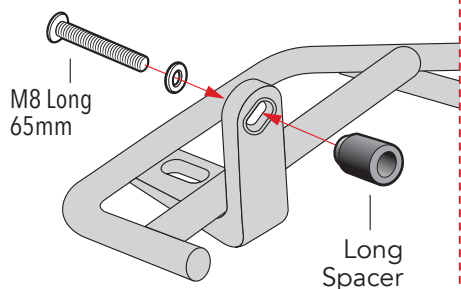

REAR LEFT SIDE

B For Boost (EVO 5)

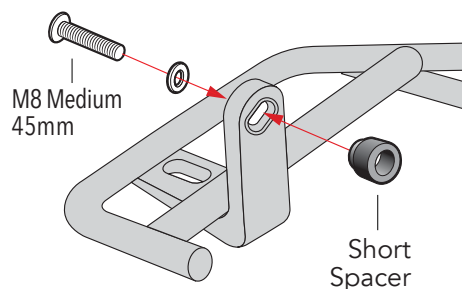

REAR LEFT SIDE

C For Boost (EVO 1,2,3,4) with aftermarket Utility Rear Rack #1 PLUS

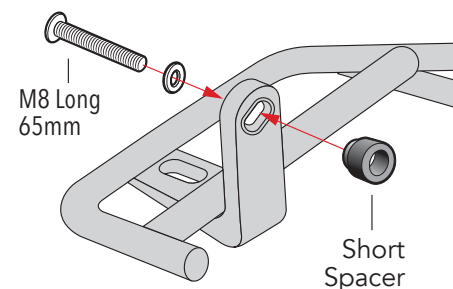

REAR LEFT SIDE

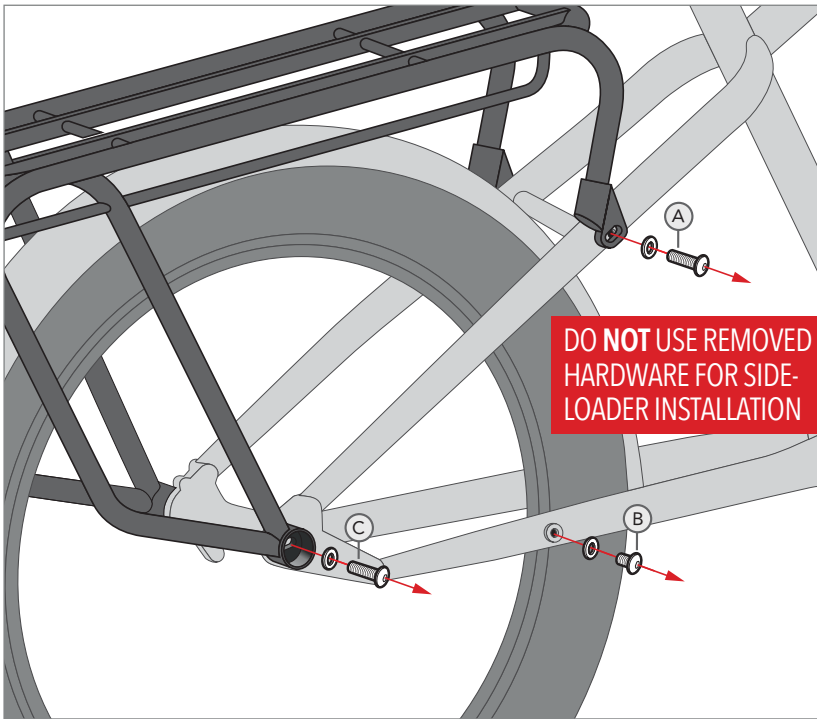

IMPORTANT! INSTALL BENNO WHEEL GUARDS OR UTILITY PANNIER BAGS BEFORE CARRYING PASSENGERS! FAILURE TO DO SO COULD RESULT IN SERIOUS INJURY!

Step 1: Remove all 3 bolts and washers (A), (B) and (C) on the right side of the rack (as shown). Loosen (but do not remove) the same 3 bolts and washers on the left side of the rack (not shown). **DO NOT USE REMOVED HARDWARE FOR SIDE-LOADER INSTALLATION.**

Step 2: Install Poly Wheel Guards (not included) by attaching all Velcro straps to the rack as shown.

Step 3: Take right Sideloader and make sure bolt (D) is loose and the forward upper bracket can move back and forth for easy alignment.

Step 4: Insert a short spacer (E) into the right side rear leg of the rack. The end with the raised center needs to point outwards (facing the Sideloader). Use M8 Medium 45mm bolt (F) and washer to secure Sideloader and rack by carefully hand tightening the bolt through the spacer and rear rack into the frame eyelet (as shown) - do not fully tighten yet.

Step 5: Insert M8 Short 30mm bolt (G) and washer through the upper front bracket of the Sideloader and rack and carefully hand tighten into the frame eyelet (as shown) - do not fully tighten yet. Position Wheel Guard lower right hole over frame eyelet. Place thin Wheel Guard spacer (included with Wheel Guards) **between** frame and Wheel Guard (raised center facing the Wheel Guard). Now secure Wheel Guard and Sideloader with M8 Short 30mm bolt (H) and washers into the frame as shown.

Step 6: Now install left Sideloader on the left side of the rack, repeating the same steps for proper installation.

EXCEPT SELECT ONE OF THE INSTALLATION OPTIONS (A,B,C) SHOWN ON FIRST PAGE. Depending on your Boost Evolution and rack configuration, different bolt and spacer combinations are needed.

Step 7: Give both Sideloaders a final adjustment to align with rack and **FIRMLY TIGHTEN ALL EIGHT BOLTS: (F), (G), (H) AND (D) ON BOTH SIDES. (MAX TORQUE 18Nm)**

After installation, take a short test ride in order to check for secure fit and ensure that everything works correctly.

Notes to owner: Periodically check to make sure all bolts remain tight as vibrations may loosen them. Ensure that either Benno Wheel Guards or Utility Pannier Bags remain on the bike while carrying passengers.

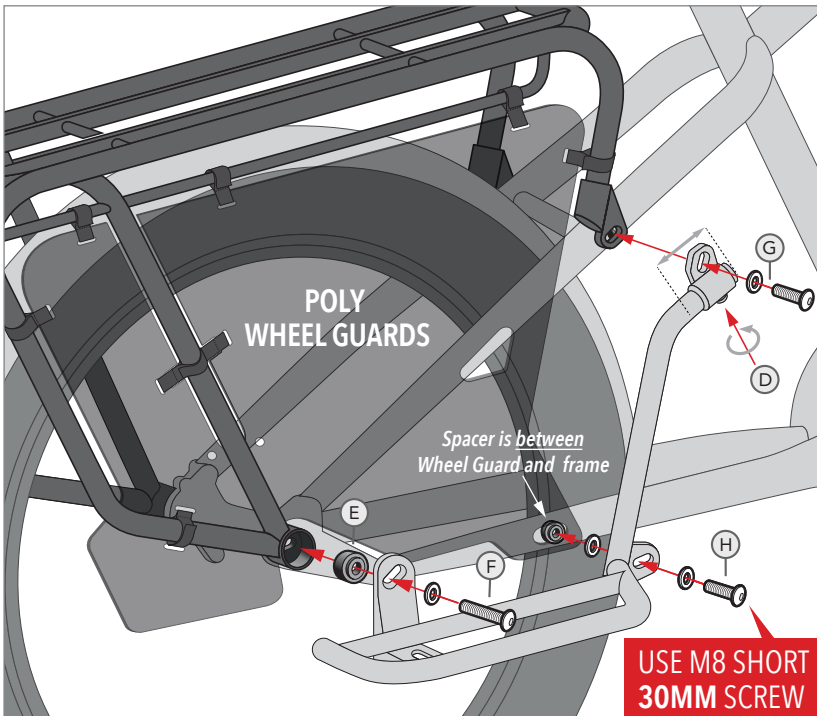

WWW.BENNOBIKES.COM/SUPPORT/BOOST_SIDELOADER_SET_POLY_WHEEL_GUARD
BOOST_SIDELOADER_INSTALLATION_MANUAL_POLY_WHEELGUARD_JAN22
COPYRIGHT 2022 BENNO® BIKES LLC

WARNING! **REAR WHEEL MUST BE COVERED!**
INSTALL BENNO WHEEL GUARDS OR UTILITY PANNIER BAGS BEFORE CARRYING PASSENGERS.
FAILURE TO DO SO COULD RESULT IN SERIOUS INJURY!



WHEN CARRYING PASSENGERS, REAR WHEEL MUST BE COVERED! INSTALL BENNO WHEEL GUARDS OR UTILITY PANNIER BAGS. FAILURE TO DO SO COULD RESULT IN SERIOUS INJURY! MAKE SURE THAT NO PARTS OF THE BODY OR CLOTHING COME NEAR MOVING PARTS ON THE BICYCLE, SUCH AS CHAIN, SPOKES, TIRES OR BRAKES. DO NOT STAND ON MINI SIDELOADERS. MAX SIDE LOAD IS 15KG/35LB EACH SIDE. HOWEVER, COMBINED RACK LOAD (DECK+SIDES) NOT TO EXCEED 60KG/130LB. FASTEN CARGO SECURELY AND MAKE SURE ALL STRAPS AND HOOKS ARE TIGHTENED.